

The logo for 'embit' is centered at the top of the page. It consists of the word 'embit' in a lowercase, sans-serif font. To the right of the text is a graphic element consisting of several concentric, curved lines that resemble a stylized signal or a partial circle. The entire logo is set against a light green background that is part of a horizontal bar.

EMB-Z2530PA

Datasheet

FCC ID: Z7H-EMB2530PA

The device complies with part 15 of the FCC Rules. Operation is subjected to the following 2 conditions: (1) this device may not cause harmful interference and (2) this device must accept any interference received, including interference that may cause undesired operation.

FCC ID: Z7H-EMB2530PA

Brand: Embit

Model: EMB-Z2530PA; EMB-Z2530; EMB-2530PA; EMB-Z253x; EMB-PWO

Power supply: 2 to 3,6 VDC

Transmission frequency: 2405 - 2480 MHz

Other certifications: CE

The device complies with part 15 of the FCC Rules. Operation is subjected to the following 2 conditions: (1) this device may not cause harmful interference and (2) this device must accept any interference received, including interference that may cause undesired operation.

This equipment has been tested and found to comply with the limits for a Class B digital device, pursuant to Part 15 of the FCC Rules. These limits are designed to provide reasonable protection against harmful interference in a residential installation. This equipment generates, uses and can radiate radio frequency energy and, if not installed and used in accordance with the instructions, may cause harmful interference to radio communications. However, there is no guarantee that interference will not occur in a particular installation. If this equipment does cause harmful interference to radio or television reception, which can be determined by turning the equipment off and on, the user is encouraged to try to correct the interference by one or more of the following measures:

- Reorient or relocate the receiving antenna.
- Increase the separation between the equipment and receiver.
- Connect the equipment into an outlet on a circuit different from that to which the receiver is connected.
- Consult the dealer or an experienced radio/TV technician for help.



This equipment is approved only for mobile and base station transmitting devices, separation distances of (i) 20 centimeters or more for antennas with gains < 6 dBi or (ii) 2 meters or more for antennas with gains \geq 6 dBi should be maintained between the antenna of this device and nearby persons during operation. To ensure compliance, operation at distances closer than this is not recommended.

Index

1 Description	5
1.1 Specifications	5
1.2 Applications	5
1.3 Block diagram	6
1.4 Microcontroller	6
1.5 Antenna	6
1.6 Power Amplifier / Low Noise Amplifier	9
1.7 Firmware	10
1.8 Developing tools	10
2 Size and footprint	11
2.1 Size	11
2.2 Connector positioning	12
2.3 Footprint	13
2.4 Antenna positioning	14
2.5 Notes	14
3 Connections	15
4 Electrical characteristics	17
4.1 Absolute Maximum Ratings	17
4.2 Operating Conditions	17
4.3 Power Consumption	17
4.4 RF Characteristic	17
5 Soldering	18
6 Compliance	19
6.1 Introduction	19
6.2 Compliance: Important information	19
6.3 CE compliance	20
6.4 CE Output power	21
6.5 FCC Data	21
6.6 FCC Output power	22
6.7 FCC - 802.15.4 channel 26	22
7 Ordering informations	23
7.1 Types	23
7.2 Packaging	23
8 Disclaimer	24
8.1 Handling precautions	24
8.2 Limitations	24
8.3 Disclaimer of liability	24
8.4 Trademarks	24

1 Description

EMB-Z2530PA is an OEM wireless module developed by **embit** for LR-WPAN applications. The module combines high performance to small dimensions and low cost, providing the system integrator a simple and easy way to add IEEE 802.15.4 / ZigBee low range wireless connectivity and multi-hop networking into existing products.

EMB-Z2530PA is configured as an embedded micro system or simple data modem for low power applications in the 2.4 GHz ISM band. It is based on a Texas Instruments™ CC2530 single chip device which is an 8051 8 bit controller with 256 KB Flash memory and 8 KB of RAM. The device includes a hardware accelerator for the MAC IEEE802.15.4 and a 2.4 GHz transceiver.

The ad-hoc RF section includes a power amplifier and a low noise amplifier which guarantee best-in-class performance in terms of covered area and power consumption. The output power can be increased up to +20 dBm by simple software configurations and the sensitivity is configurable between two options, allowing to cover distances up to 500 meters (LoS); the U.FL receptacle allows the connection of an external antenna.

EMB-Z2530PA can communicate with other devices through a wide range of serial interfaces: two UART ports, SPI, several digital I/O ports (up to 16 digital lines) and one analog port.

1.1 Specifications

- 8-bit 8051 MCU
- 256 KB Flash, 8 KB RAM
- Output power: up to +20 dBm (100 mW)
- Sensitivity: up to -100 dBm (high sensitivity mode)
- PCB antenna (PIFA), wire connector and U.FL receptacle for external antennas
- Coverage: up to 500 meters (LoS)
- Unique IEEE address (64 bit) on-board
- SMD edge connector

1.2 Applications

- **Metering:** thermostat, meters, remote devices, displays, etc..
- **Home/Buildings Automation:** safety systems and access control, HVAC, door/window control, lightning, etc..
- **Industrial Automation:** process control, wireless sensor networks, identification and asset tracking, etc..
- **Healthcare:** blood pressure monitoring, thermometers, ECG, etc..

1.3 Block diagram

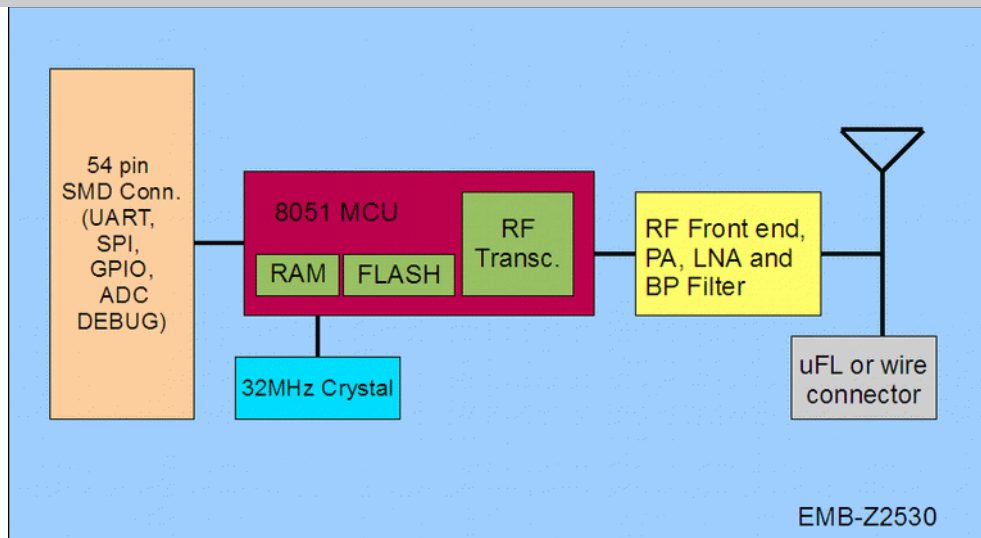

Image 1: block diagram for the **EMB-Z2530PA**

1.4 Microcontroller

CC2530 is an integrated Texas Instruments™ platform for IEEE 802.15.4/ZigBee. The device integrates a low power 2.4 GHz transceiver, a CPU based on an 8051 core (8 bit) and a hardware accelerator for the IEEE 802.15.4 MAC.

The CC2530 can be used for different wireless applications, starting from the simple point to point proprietary protocol to ZigBee mesh networks, and has been developed to offer high computational power with low consumption.

The 8051 8 bit core works at 32 MHz; there is 256 KB of flash memory and 8 KB of RAM memory.

1.5 Antenna

The **EMB-Z2530PA** module offers three different antenna options:

- PIFA antenna directly printed on the PCB with an omnidirectional emission diagram (xz plane). The performances of this antenna are influenced by the positioning of the module in the system (see paragraph “Antenna positioning”). The antenna specifications are provided in next paragraph.
- Wire antenna: hole for soldering a wire antenna.
- External antenna connector (optional): 50 Ohm single ended U.FL connector.

1.5.1 PIFA antenna radiation diagrams

The printed antenna of the **EMB-Z2530PA** is a simple and performant solution for a 2,4 GHz system. It has a maximum gain of +1,5 dBi, positioned in the xy plane perpendicular to the module (see 3D radiation diagram).

Here is the 3D radiation pattern:

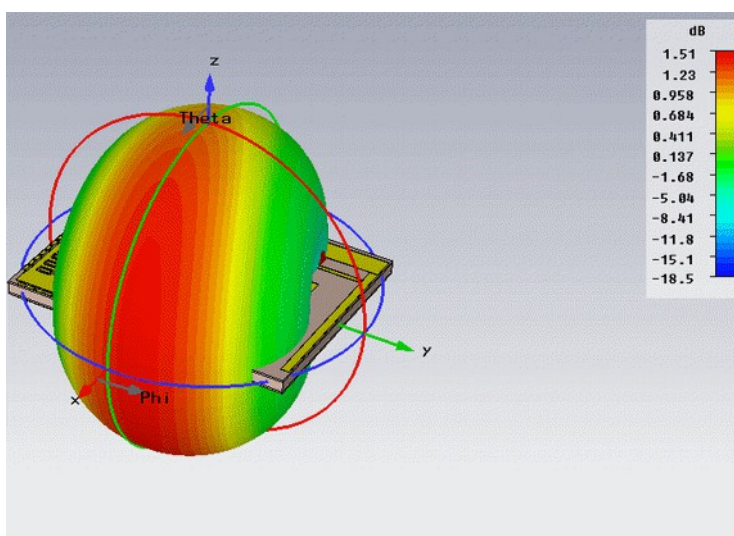

Image 2: 3D radiation pattern

Polar radiation pattern:

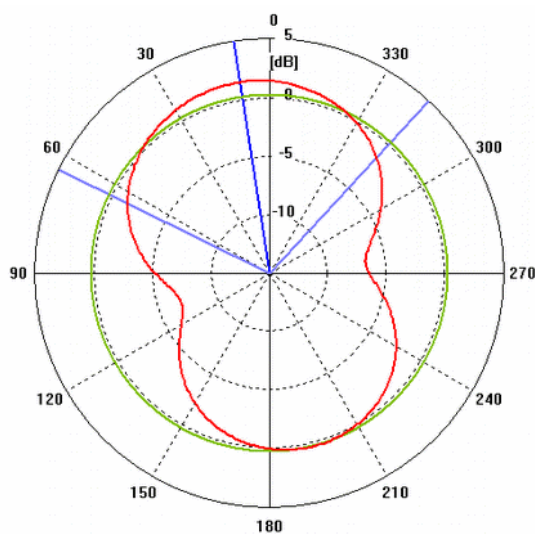

Image 3: polar radiation pattern, xy plane

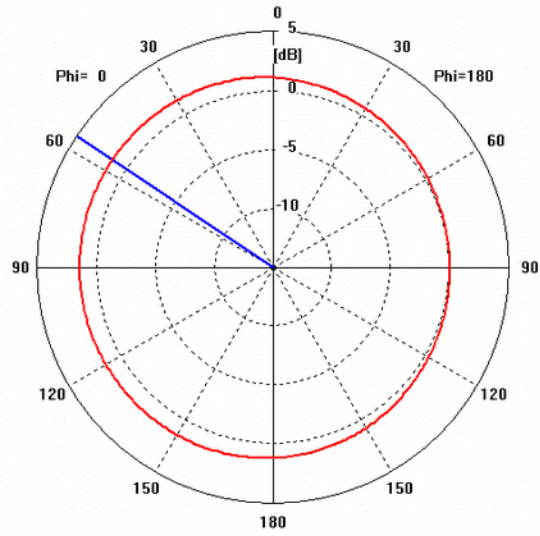

Image 4: polar radiation pattern, yz plane

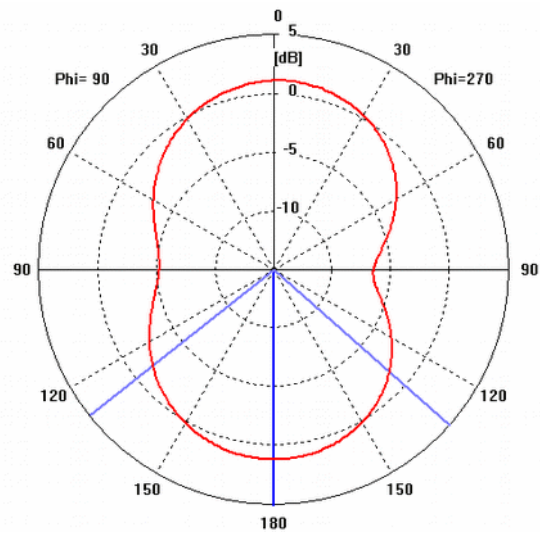

Image 5: polar radiation pattern, xz plane

1.5.2 Antenna selection (PIFA/external)

To select the antenna option the last 0402 resistor (zero R) or capacitor (10 pF) in the RF chain (the one closer to the printed antenna) must be rotated from vertical to horizontal position and viceversa. If the PIFA antenna is desired, the component must be installed in vertical position, as shown in the following picture:

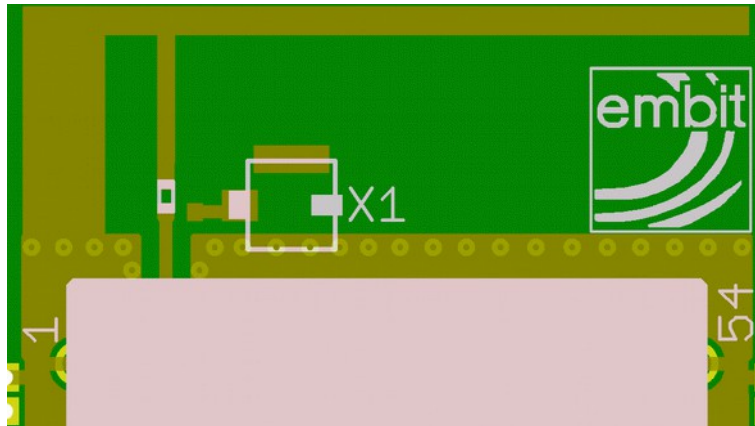

Image 6: C3 capacitor installation for PIFA antenna

If an external antenna is to be used, either through U.FL connector or wire soldering point, the C3 capacitor must be installed in horizontal position, as shown in the following picture:

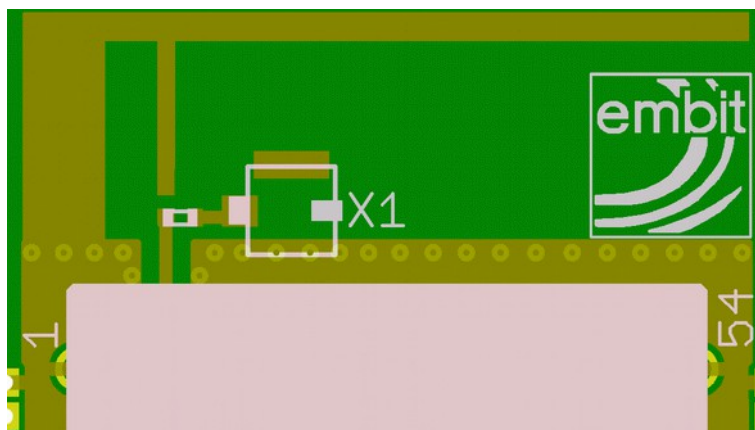

Image 7: C3 capacitor installation for external antenna

1.6 Power Amplifier / Low Noise Amplifier

The **EMB-Z2530PA** module is equipped with a PA / LNA combination to increase the communication range of the device. The PA provides a fixed gain of +20 dBm and the LNA can provide a gain of +11 dBm or +1 dBm selectable from the MCU. To switch between low gain and high gain the MCU must drive the pin 0 of port R low (high gain) or high (low gain).

1.7 Firmware

The EMB-Z2530PA is compatible with the TIMAC stack and Z-Stack provided by Texas Instruments. Some modifications must be done to drive the external PA and LNA. For an insight guide, please consult the appropriate documents.

1.7.1 Power Amplifier interface

The EMB-Z2530PA has an integrated power amplifier and low noise amplifier that must be controlled by the transceiver. Depending on the stack some modifications might be required in order to control the front-end. The interface between transceiver and front-end is composed of an SPI port and three GPIO pins: Enable, PA_enable and Low/High_Sensitivity.

The Enable pin (for controlling the LNA) is remapped from P1.4 to P1.0 when comparing to Texas Instruments Evaluation Modules and so the right settings for OBSSEL0:

```
OBSSEL0 = RFC_OBS_CTRL1;  
// OBSSEL4 = RFC_OBS_CTRL1;
```

1.7.2 Switches and LEDs

Depending on the board in which the EMB-Z2530PA module will be mounted, some remapping of the LED and switch pins might be required. For further information please consult the appropriate documents.

1.8 Developing tools

For programming the EMB-Z2530PA any emulator provided by Texas Instruments™ might be used (CC Debugger, SmartRF, etc.). The IAR IDE is suggested for working with the stacks.

2 Size and footprint

2.1 Size

The mechanical dimensions of the **EMB-Z2530PA** are, as every other module from Embit: 29,50 x 22,60 mm. The thickness is 3,6 mm, CAN Shield included.

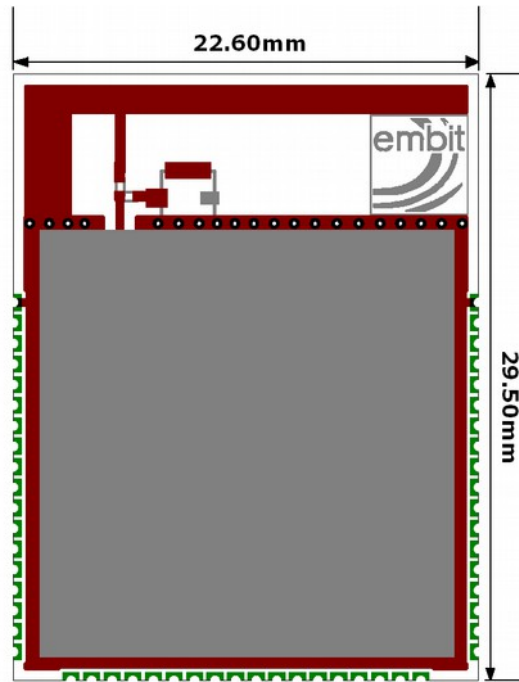

Image 8: Outline

2.2 Connector positioning

The EMB-Z2530PA module has three 18 pin “edge” connector with a 1,00 mm pitch, for a sum of 54 contacts. Each pin is a metallized half hole 0,50 mm in diameter. The positioning of the connector is shown in the following images:

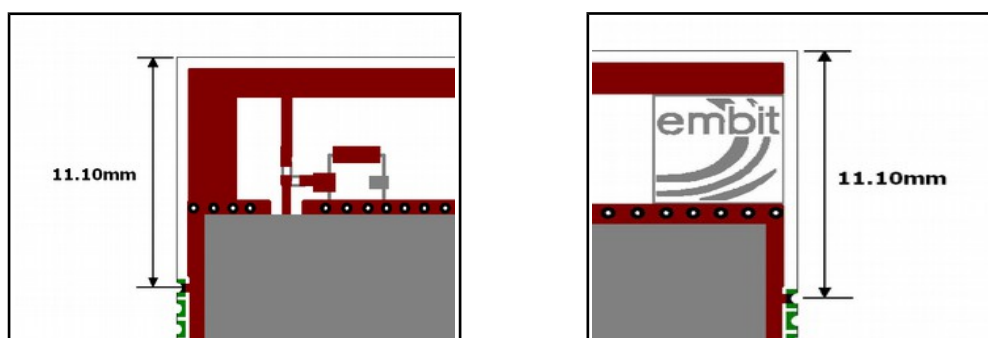

Image 9: Connector positions

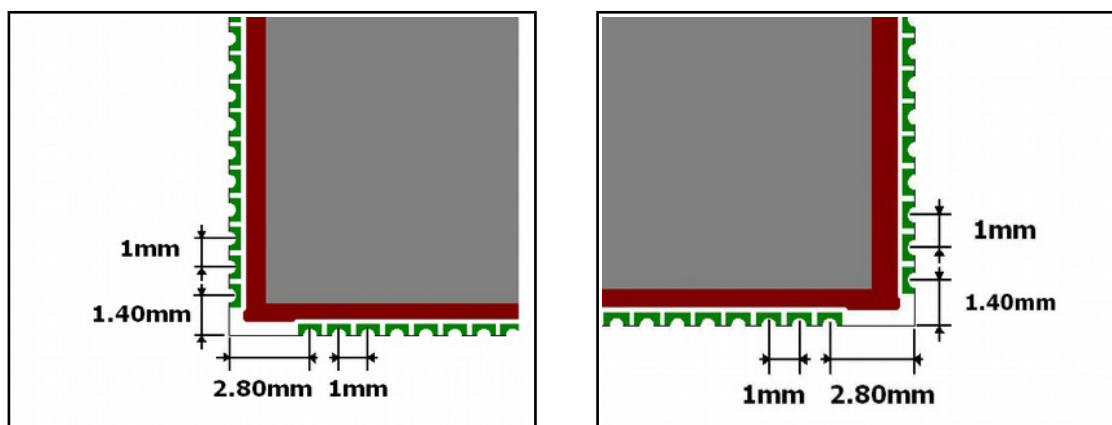

Image 10: Connector positions

2.3 Footprint

The EMB-Z2530PA footprint consists in 54 smd pads 1,00 x 0,80 mm in dimensions positioned as following:

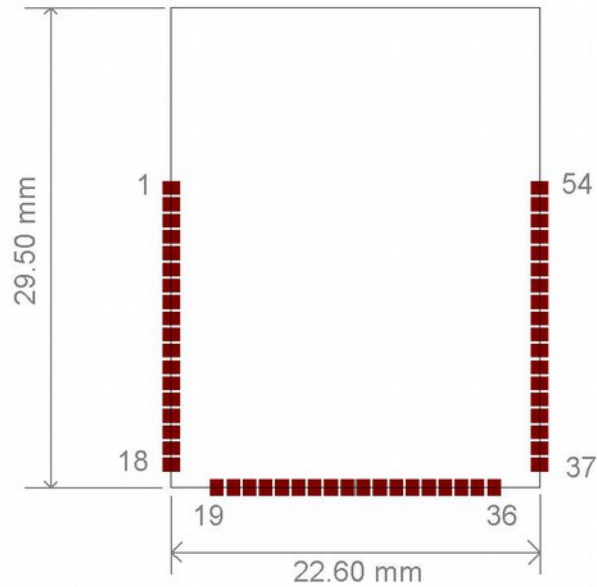

Image 11: Footprint EMB-Z2530PA

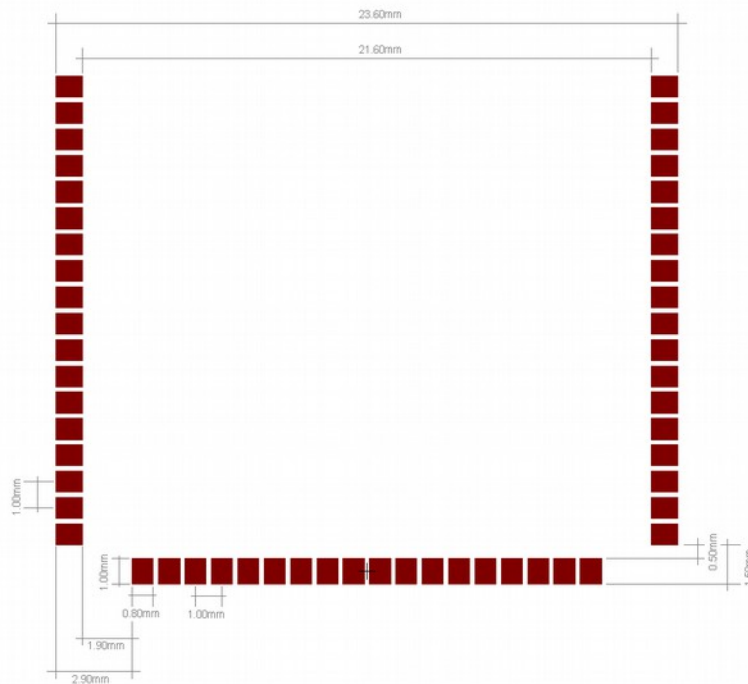

Image 12: Pad distribution

2.4 Antenna positioning

The module must be installed on a PCB, keeping the area dedicated for the PIFA antenna outside the PCB outline. In the following image is shown an example of installation:

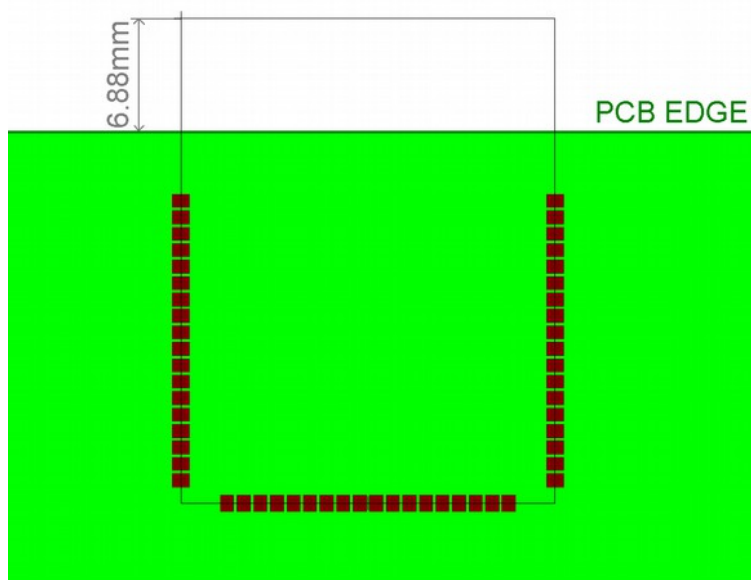

Image 13: Antenna positioning

2.5 Notes

- The area underneath the module must be kept free of components (both top and bottom layers) and must be covered with solder resist.
- The PCB top layer underneath the module must be free of nets, power planes and vias. The bottom layer shall provide a ground plane.
- The power supply of the module must be as clean as possible; it must be decoupled placing a ceramic capacitor as near as possible at the Vcc pins, additional filtering made by a ferrite bead is recommended.
- Noisy electronic components (such as switching power supply) must be placed as far as possible and adequately decoupled.
- The ground pins of the module shall be connected to a solid ground plane.
- Keep antenna clear of metal parts of the casing or system.
- Don't use metal enclosures to avoid RF signal degradation.

Note: Taking no account this recommendations may affect the radio performances.

3 Connections

Pin #	Pin Name	Type	Description	IC Pin #
1	GND	GND	GND	--
2	N.C.	Not connected	-	--
3	N.C.	Not connected	-	--
4	N.C.	Not connected	-	--
5	P0.0_ADC0	Analog input or Digital Input/Output	ADC analog input Channel 0 / P0.0	19
6	P0.0_ADC0	Analog input or Digital Input/Output	ADC analog input Channel 0 / P0.0	19
7	N.C.	Not connected	-	--
8	N.C.	Not connected	-	--
9	N.C.	Not connected	-	--
10	N.C.	Not connected	-	--
11	N.C.	Not connected	-	--
12	N.C.	Not connected	-	--
13	P2.1_DEBUG_DATA	Digital Input/Output	Debug data / P2.1	35
14	N.C.	Not connected	-	--
15	P2.2_DEBUG_CLOCK	Digital Input/Output	Debug clock / P2.2	34
16	N.C.	Not connected	-	--
17	N.C.	Not connected	-	--
18	VCC	Power Input	Supply voltage	--
19	N.C.	Not connected	-	--
20	P1.7_UART2_RX	Digital Input/Output	UART2 rx data input / P1.7	37
21	P1.6_UART2_TX	Digital Input/Output	UART2 tx data output / P1.6	38
22	P0.5_UART1_RTS	Digital Input/Output	UART1 request to send input / P0.5	14
23	P0.4_UART1_CTS	Digital Input/Output	UART1 clear to send output / P0.4	15
24	P0.2_UART1_RX	Digital Input/Output	UART1 rx data input / P0.2	17
25	P0.3_UART1_TX	Digital Input/Output	UART1 tx data output / P0.3	16
26	N.C.	Not connected	-	--
27	N.C.	Not connected	-	--
28	N.C.	Not connected	-	--
29	N.C.	Not connected	-	--
30	P1.4_TMR3.1	Digital Input/Output	Timer 3 IO signal / P1.4	6
31	P1.3_TMR3.0	Digital Input/Output	Timer 3 IO signal / P1.3	7
32	P1.3_SPI_SCK	Digital Input/Output	SPI Port Clock / P1.3	7

Connections

Pin #	Pin Name	Type	Description	IC Pin #
33	P1.5_SPI_MOSI	Digital Input/Output	SPI Port MOSI / P1.5	5
34	P1.4_SPI_MISO	Digital Input/Output	SPI Port MISO / P1.4	6
35	P1.2_SPI_SS	Digital Input/Output	SPI Port Slave Select / P1.2	8
36	N.C.	Not connected	-	--
37	VCC	Power Input	Supply voltage (Buck regulator & I/O buffers)	--
38	N.C.	Not connected	-	--
39	N.C.	Not connected	-	--
40	N.C.	Not connected	-	--
41	N.C.	Not connected	-	--
42	N.C.	Not connected	-	--
43	P0.1_GPIO3	Digital Input/Output	IO (Switch 2) / P0.1	18
44	P0.6_GPIO1	Digital Input/Output	IO (Switch 1) / P0.6	13
45	N.C.	Not connected	-	--
46	N.C.	Not connected	-	--
47	P1.2_SPI_SS	Digital Input/Output	IO (LED2) / P1.2 / SPI SS	8
48	P2.0_GPIO2	Digital Input/Output	IO (LED1) / P2.0	36
49	P2.3_X32K_Q2	Analog input or Digital Input/Output	Optional 32,768KHz crystal oscillator input / P2.3	33
50	P2.4_X32K_Q1	Analog output or Digital Input/Output	Optional 32,768KHz crystal oscillator output / P2.4	32
51	RESET#	Digital Input	System reset input (active low)	20
52	N.C.	Not connected	-	--
53	N.C.	Not connected	-	--
54	GND	GND	GND	--

4 Electrical characteristics

4.1 Absolute Maximum Ratings

	Value	Unit
Power Supply Voltage	+3,6	Vdc
Voltage on any pin	Vcc+0,3 (Max 3,6)	Vdc
RF input power (P _{MAX})	10	dBm
Storage Temp. Range	-45 ~ +125	°C

4.2 Operating Conditions

Parameter	Min	Typ	Max	Unit
Power Supply Voltage (Vcc)	2,1		3,6	Vdc
Input Frequency	2405		2480	MHz
Operating Temperature Range	-40		85	°C
Logic Input Low Voltage (@ Vdd = 3 V)	0		0,5	Vdc
Logic Input High Voltage (@ Vdd = 3 V)	2,5		Vcc	Vdc
Logic Output Low Voltage (@ Vdd = 3 V)	0		0,5	Vdc
Logic Output High Voltage (@ Vdd = 3 V)	2,4		Vcc	Vdc

4.3 Power Consumption

Mode	Typ. value	Unit
Transmission @ +20 dBm (MCU core running)	154	mA
Transmission @ +12 dBm (MCU core running)	84.8	mA
Receive (MCU core running)	29.3	mA
Idle (MCU core running, radio off)	6.8	mA
Sleep (MCU core and radio sleeping)	Up to 1.1*	µA

* 1.1 µA can be obtained in power mode 2 with sleep timer running.

NOTE: all values are referred to the EMB-Z2530PA/IA (model with integrated PCB antenna)

4.4 RF Characteristic

Parameter	Min	Typ	Max	Unit
RF Frequency Range	2400		2483,5	MHz
RF Data Rate		250		kbps
Nominal Output Power	--	+10	--	dBm
Programmable Output Power Range	+4	--	+20	dBm
Receiver Sensitivity (1% PER) - Normal mode	--	-91	--	dBm
Receiver Sensitivity (1% PER) - High sensitivity mode	--	-100	--	dBm
Saturation (IP3) - Maximum Input Level	-2			dBm

5 Soldering

Temperature profile for reflow soldering:

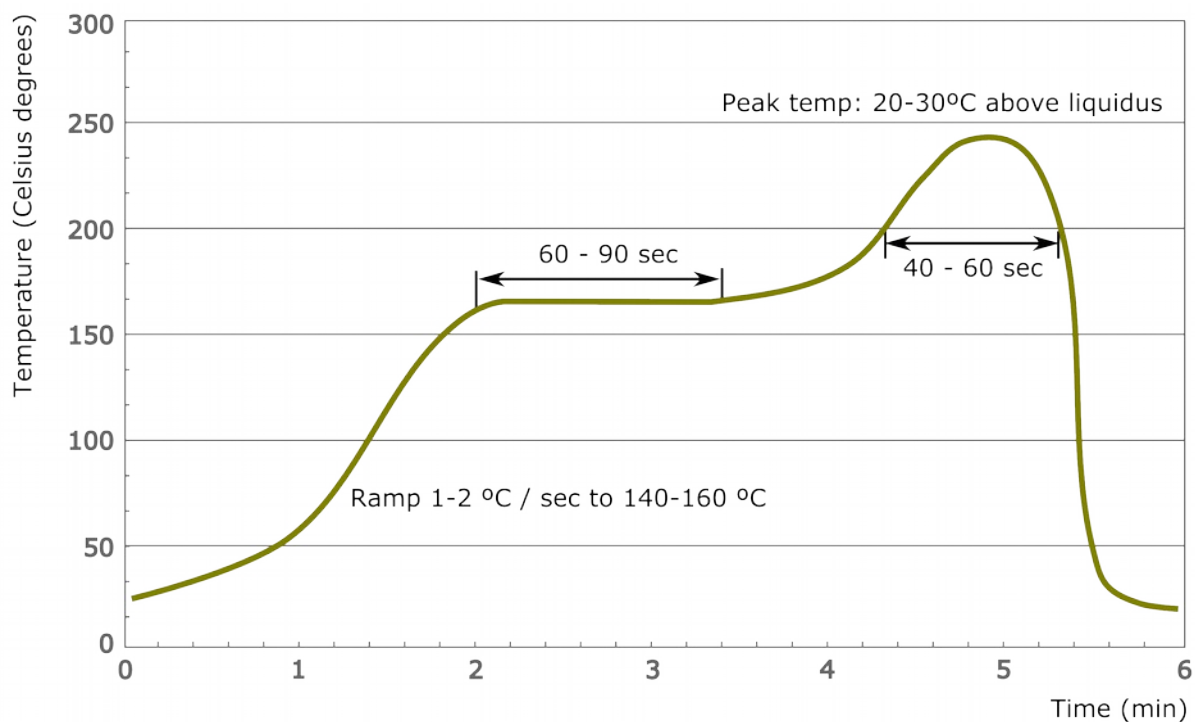

Pb-Free Soldering Paste: it is suggested to use soldering pastes that don't need later clean for residuals.

Cleaning: it's not suggested to clean the module. Solder paste residuals underneath the module cannot be removed.

- Water cleaning: the cleaning process using water can involve water entering underneath the module between the two PCBs creating short circuits.
- Alcohol cleaning: the cleaning process with alcohol can damage the module.
- Ultrasound cleaning: the cleaning process with ultrasound can damage the module.

It is suggested to use no clean solder paste to avoid any need for cleaning.

Cycles: it is suggested to do only one soldering cycle.

In case of reflow soldering, a drying bake should be done in order to prevent a popcorn effect. Re-baking should be done following IPC standards. Any unused modules that has been open for more than 168 hours or not stored at <10% RH should be baked before any subsequent reflow.

6 Compliance

6.1 Introduction

The purpose of this chapter is to describe which behaviour the user **MUST** have in order to operate the device under compliance with current regulations. The details described here are then to be read carefully and applied literally. Also, please read carefully all the other documentation available in order to understand all the limits and ensure compliance of the final application.

The module **EMB-Z2530PA** is certified for CE and FCC compliance. The different regulations have different limitations and impose different approaches to the module that will be discussed in different chapters. Any aspect that both the regulations have in common will be described in an appropriate chapter in order to keep readability of this document at maximum.

The main aspect that the user **MUST** consider is the output power. The module itself is compliant and ready to be used but care must be taken in setting an appropriate output power when programming the devices. The module can output up to 20 dBm of conducted power which translates into up to 21.5 dBm of eirp with the integrated antenna or more if using an external antenna. Please follow the directives in this document to set the appropriate output power for the antenna you are using. Any other antenna that is not covered in the certification must not be used unless a new certification is performed.

6.2 Compliance: Important information

The module is to be used in accordance with the current guide.

The antennas used must be one of those indicated by the manufacturer and the output power must be set as required by the present document.

There is no duty cycle limit for this module if the appropriate power settings are respected.

Any modification on the module will void the certification.

The module can only be used with the antennas specified in the following table and the power setting must not exceed those indicated in this table for each antenna and operative area (CE or FCC). For correctly operate the modules with the stack provided please set the output power according to the following table. The “Maximum tx power” column refers to the power to be set in the stack and might differ slightly from the effective output power (see power tables). If the module is using the integrated antenna, please consider the settings specified for the EMB-AN24-15PFA antenna.

Antenna code	Antenna type	Antenna gain	Maximum tx power (for CE)	EIRP (for CE)	Maximum tx power (for FCC)	EIRP (for FCC)
EMB-AN24-14YA	Yagi	+14,0 dBi	+1 dBm	15,0 dBm	+20 dBm	34,0 dBm

Antenna code	Antenna type	Antenna gain	Maximum tx power (for CE)	EIRP (for CE)	Maximum tx power (for FCC)	EIRP (for FCC)
EMB-AN24-12YA	Yagi	+12,0 dBi	+2 dBm	14,0 dBm	+20 dBm	32,0 dBm
EMB-AN24-20HWDU	1/2 wave dipole captive mount	+2 dBi	+12 dBm	+14,0 dbm	+20 dBm	+22,0 dbm
EMB-AN24-00QWS	1/4 wave stubby	+0 dBi	+14 dBm	+14,0 dbm	+20 dBm	+20,0 dbm
EMB-AN24-21DBA	Dual band antenna	+2,1 dBi	+12 dBm	+14,1 dbm	+20 dBm	+22,1 dbm
EMB-AN24-50FPCBA	Flexible PCB antenna	+5 dBi	+9 dBm	+14,0 dbm	+20 dBm	+25,0 dbm
EMB-AN24-25FPCBABD	Flexible PCB antenna	+2,5 dBi	+12 dBm	+14,5 dbm	+20 dBm	+22,5 dbm
EMB-AN24-25FPCBA	Flexible PCB antenna	+2,5 dBi	+12 dBm	+14,5 dbm	+20 dBm	+22,5 dbm
EMB-AN24-15FPCBA	Flexible PCB antenna	+1,5 dBi	+13 dBm	+14,5 dbm	+20 dBm	+21,5 dbm
EMB-AN24-22MA	Mini antenna	+2,2 dBi	+12 dBm	+14,2 dbm	+20 dBm	+22,2 dbm
EMB-AN24-15MA	Mini antenna	+1,5 dBi	+13 dBm	+14,5 dbm	+20 dBm	+21,5 dbm
EMB-AN24-40SMA	Multi frequency antenna	+4 dBi	+11 dBm	+15,0 dbm	+20 dBm	+24,0 dbm
EMB-AN24-20SMA	Multi frequency antenna	+2 dBi	+11 dBm	+15,0 dbm	+20 dBm	+22,0 dbm
EMB-AN24-70pA	Portable swivel antennas panel	+7 dBi	+7 dBm	+14,0 dbm	+20 dBm	+27,0 dbm
EMB-AN24-50pA	Portable swivel antennas panel	+5 dBi	+9 dBm	+14,0 dbm	+20 dBm	+25,0 dbm
EMB-AN24-50SA	Portable swivel antennas panel	+5 dBi	+9 dBm	+14,0 dbm	+20 dBm	+25,0 dbm
EMB-AN24-40pA	Portable swivel antennas panel	+4 dBi	+11 dBm	+15,0 dbm	+20 dBm	+24,0 dbm
EMB-AN24-15PFA	Printed PCB antenna - pifa	+1,5 dBi	+11 dBm	+12,5 dbm	+20 dBm	+21,5 dbm
EMB-AN24-55RDD	Rubber duck - dipole antenna	+5,5 dBi	+9 dBm	+14,5 dbm	+20 dBm	+25,5 dbm
EMB-AN24-50RDD	Rubber duck - dipole antenna	+5 dBi	+9 dBm	+14,0 dbm	+20 dBm	+25,0 dbm
EMB-AN24-22WMA	Wall mount antenna	+2,2 dBi	+12 dBm	+14,2 dbm	+20 dBm	+22,2 dbm
EMB-AN24-10PA	Patch antenna	+10 dBi	+5 dBm	+15,0 dBm	+20 dBm	+30,0 dBm
EMB-AN24-12CA	Corner antenna	+12 dBi	+2 dBm	+14,0 dBm	+20 dBm	+32,0 dBm

6.3 CE compliance

The EMB-Z2530PA is in compliance with the essential requirements and other relevant provisions of Directive 1999/5/EC.



The Declaration of Conformity made under Directive 1999/5/EC is available for viewing at the following location in the EU community:

Embit s.r.l.
via Emilia Est, 911
41122 Modena (MO)
Italy

WARNING: The exclamation mark indicates that this device is classified as “Class 2” radio equipment. The radio equipment is reprogrammable. It is not guaranteed that all limits and regulation compliance are satisfied once the device is reprogrammed. The user must take the full responsibility of operating the module properly satisfying regulation constrains that applies. The antenna is permanently attached to the card, removing the included antenna or modifying the board or antenna connector invalidates the certification.

This radio module has been designed to be embedded into other products (“final products”). According to the RTTE directive, the declaration of compliance and the “CE” labeling is within the responsibility of the manufacturer of the final product.

6.4 CE Output power

The CE regulation allows for up to 20 dBm of EIRP output power but imposes a maximum power spectral density of +10 mW/MHz. Considering the bandwidth of the 802.15.4 and ZigBee, this translates into a reduction of the maximum usable output power. Also spurious emission regulations might impose a lower output power. Consider the antennas table from previous chapter for setting the right output power.

6.5 FCC Data

FCC ID: Z7H-EMB2530PA

Brand: Embit

Model: EMB-Z2530PA; EMB-Z2530; EMB-2530PA; EMB-Z253x; EMB-PWO

Power supply: 2 to 3,6 VDC

Transmission frequency: 2405 - 2480 MHz

Other certifications: CE

The device complies with part 15 of the FCC Rules. Operation is subjected to the following 2 conditions: (1) this device may not cause harmful interference and (2) this device must accept any interference received, including interference that may cause undesired operation.

This equipment has been tested and found to comply with the limits for a Class B digital device, pursuant to Part 15 of the FCC Rules. These limits are designed to provide reasonable protection against harmful interference in a residential installation. This equipment generates, uses and can radiate radio frequency energy and, if not installed

and used in accordance with the instructions, may cause harmful interference to radio communications. However, there is no guarantee that interference will not occur in a particular installation. If this equipment does cause harmful interference to radio or television reception, which can be determined by turning the equipment off and on, the user is encouraged to try to correct the interference by one or more of the following measures:

- Reorient or relocate the receiving antenna.
- Increase the separation between the equipment and receiver.
- Connect the equipment into an outlet on a circuit different from that to which the receiver is connected.
- Consult the dealer or an experienced radio/TV technician for help.

This equipment is approved only for mobile and base station transmitting devices, separation distances of (i) 20 centimeters or more for antennas with gains < 6 dBi or (ii) 2 meters or more for antennas with gains ≥ 6 dBi should be maintained between the antenna of this device and nearby persons during operation. To ensure compliance, operation at distances closer than this is not recommended.

6.6 FCC Output power

The FCC regulation allows for up to 30 dB or output power plus up to 6 dBi of assembly gain which translates into up to +36 dBm of EIRP. The modules EMB-Z253x can output up to +20 dBm and so, when using the allowed antennas, will have no problems with the output power limit. Spurious emission and spectral density doesn't limit the output power neither on the EMB-Z253x and so every output power setting can be used.

6.7 FCC - 802.15.4 channel 26

When using the channel 26 of the 802.15.4 frequency band special care must be taken. The FCC regulations impose a spectral power mask with a falling edge too close in frequency to the channel 26. To keep compliance with FCC regulation, avoid using channel 26, lower the output power by 10 dBm or use a duty cycle lower than 33 %.

7 Ordering informations

7.1 Types

Module variations:

Part No.	Description
EMB-Z2530PA/IA	EMB-Z2530PA integrated PIFA antenna
EMB-Z2530PA/UL	EMB-Z2530PA U.FL connector for external antenna

Related products:

Part No.	Description
EMB-Z2530PA-EVK	EMB-Z2530PA Evaluation Kit

7.2 Packaging

Embit's modules are delivered in tubes, each tube including 20 items.

The tube dimensions are approximately: 508mm x 33mm x 8mm.

8 Disclaimer

The user must read carefully all the documentation available before using the product. In particular, care must be taken in order to comply with the regulations (i.e. power limits, duty cycle limits, etc.).

8.1 Handling precautions



This product is an ESD sensitive device. Handling precautions should be carefully observed.

8.2 Limitations

Every operation involving a modification on the internal components of the module will void the warranty.

8.3 Disclaimer of liability

The information provided in this and other documents associated to the product might contain technical inaccuracies as well as typing errors. Regulations might also vary in time. Updates to these documents are performed periodically and the information provided in these manuals might change without notice. The user is required to ensure that the documentation is updated and the information contained is valid. Embit reserves the right to change any of the technical/functional specifications as well as to discontinue manufacture or support of any of its products without any written announcement.

8.4 Trademarks

Embit is a registered trademark owned by Embit s.r.l.

All other trademarks, registered trademarks and product names are the sole property of their respective owners.